

INPUT KEY

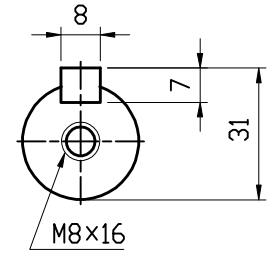

OUTPUT KEY

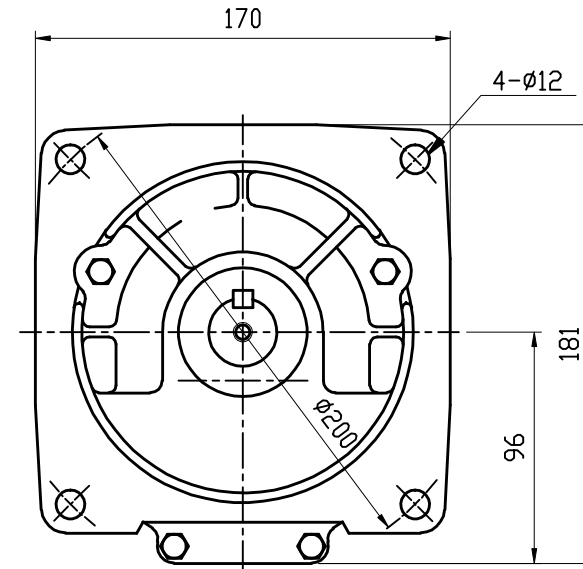
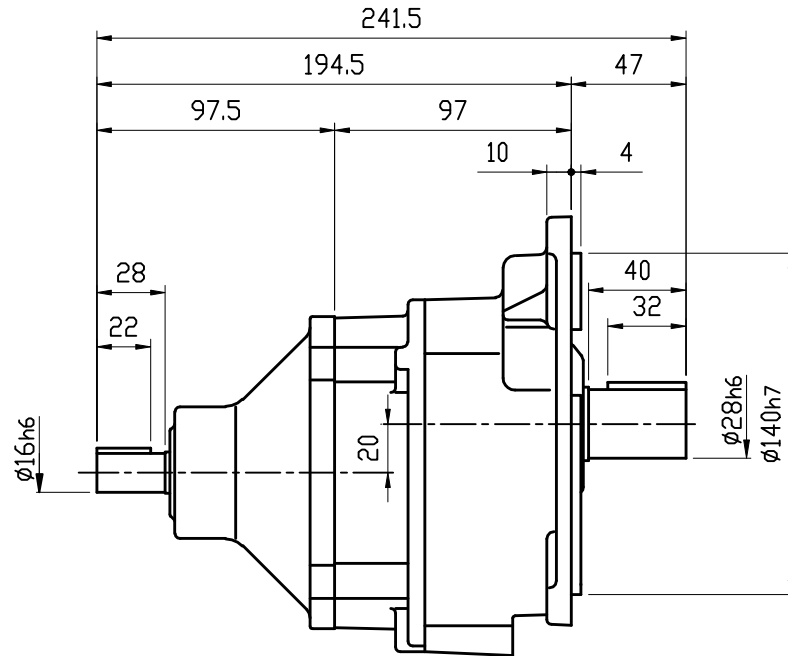

MOTOR (THREE PHASE INDUCTION MOTOR) モーター仕様 (三相誘導電動機)		GEARED SPECIFICATION 減速機仕様	
CAPACITY 出力	0.4 kW	RATIO 減速比	1/40, 1/45 1/50
REVOLUTION 回転速度	1500/1800 r/min	LUBRICANT 潤滑方式	GREASE グリース
		COLOR 塗装色	SILVER シルバー
		TOTAL WEIGHT 製品質量	4 kg

DATE 日付	2013.9.3	USER 納入先	
SCALE 尺度	1:3	TYPE 型式	VX04-040~050GF
APPROVED 承認	A. YAMADA	NAME 名称	VX SERIES REDUCER TYPE VXシリーズ減速機タイプ
CHECKED 照査	T. OHTSUBO	DRAWING No. 図番	ND-04050GF-P1
DRAWN 作成	K. NARIHARA	富士変速機株式会社 FUJIHENSOKUKI CO., LTD	